



**TEK 380-HD HDMI/SDI
Conference Camera
User's Guide**



V031015

Table of Contents

Overview	4
Main Features	4
Camera and Lens.....	5
Pan/Tilt Movement	5
Rear Connectors	6
RS-232 Pin Out	6
OSD Menu	8
Self-testing OSD Menu.....	8
Dome OSD	8
LENS OSD	9
IR Remote Controller.....	10
Camera Switch Settings	11
SW1 Address Setting Table	11
SW2 Communication Protocol Settings.....	11
IR Address Select.....	12
Installation	12
Size	12
Specifications	13
VISCA PROTOCOL.....	15
Command Set	15
Inquiry Command List	17



Overview

The TEK 380-HD conference camera is a high definition PTZ camera with 10X optical zoom lens and has both HDMI and SDI outputs. With its small size, 16:9 aspect ratio, 2.1 Mega pixel CCD, and 64 presets, this camera is an excellent choice for videoconferencing rooms and lecture capture systems. The camera can be setup for multiple resolutions and be ceiling mounted. Having a smaller size than most similar quality cameras allows for smaller mounting brackets and cubby holes. This also makes the camera not as visually intrusive as larger ones. The camera can be controlled using the Sony® VISCA™ or the PELCO P/D Command set. This makes the camera directly replaceable with other like cameras.

Main Features

One of the most important features of this camera is that it can support 64 presets (PELCO) 63 (VISCA) within the camera. This makes the camera much easier to control as compared to other cameras that are only 6 to 15 presets. Other features include up to 1080i@60 resolution with both HDMI and SDI outputs.



Camera and Lens

- Video CMOS Sensor: 1/2.5 inch super quality HD CMOS transducer
- Image: 16:9 2.1 Mega pixel
- Resolution: HD 1080i@60; 1080p30; 720p/30; 720p/60
- Lens zoom: 10x optical zoom, f=4.5-45mm F1.8-2.2
- Focus, 1.0Lux at F 1.8
- Wide angle lens: 0.7x wide angle lens, caliber 30mm
- Visual Angle: 5.4°(farness) -70°(nearness)
- Minimum Illumination: 10LUX
- White Balance: Auto/Sunlight/Cloudiness/Shade/fluorescence white balance mode
- Focus: Auto/Manual
- Iris: Auto/Manual Electronic
- Shutter: Auto Black light compensation: Auto
- S/N Ratio: 50dB3.
- Auto sensing position for ceiling installations

Pan/Tilt Movement

- Pan Rotation: ± 177.5 degree
- Tilt Rotation: ± 45 degree
- Pan speed: 0.5°- 200°/sec
- Tilt speed: 0.5°-150°/sec
- Preset Speed: Pan running: 120°/sec
- Tilt running: 100°/sec
- Preset: 64 preset position

Rear Connectors

- HD-SDI
- HDMI
- IR Receiver
- RS-232 In and Out
- RS-485 (Input Connector)
- 12V DC

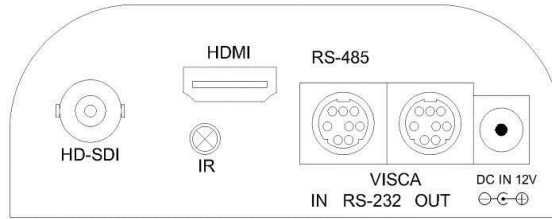

RS-232 Pin Out

Camera is shipped with a VISCA to DB-9 Female and an RS-485 adapter cable. When connecting the camera to a control system, use the supplied RS-232 cable and connect to the RS-232 Input connector. Only the TX, RX, and GND need to be connected.

Input Connector – Connect to Control System using a straight through DB-9 and supplied RS-232 Cable.

No	Function
1	DTR IN
2	DSR IN
3	TXD IN
4	GND
5	RXD IN
6	GND
7	NO Connection
8	NO Connection

VISCA RS-232C IN

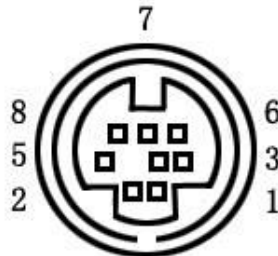

RS-232C OUT Connector

No	Function
1	DTR OUT
2	DSR OUT
3	TXD OUT
4	GND
5	RXD OUT
6	GND
7	NO Connection
8	NO Connection

VISCA RS-232C OUT

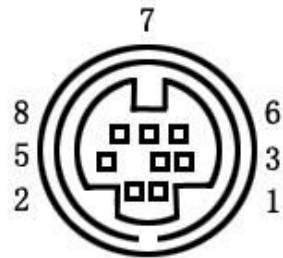

Camera Union

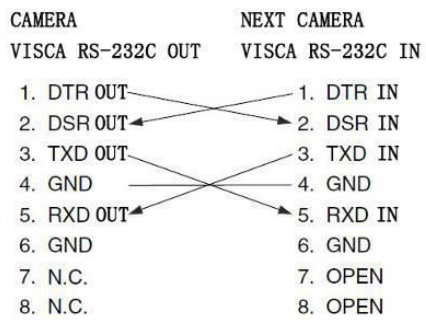

OSD Menu

Access OSD menu to view the features of camera and change the settings. **Note:** Camera cannot move pan/tilt when OSD menu is displayed.

Self-testing OSD Menu

When the camera is powered on, it performs a self-test and displays an OSD menu as follows:

- ADDRESS (Camera address)
- BUADRATE (Camera baud rate)
- PROTOCOL (PTZ Control Protocol)
- CONTROL (Camera control type)
- LENS TYPE (Camera module adopted)
- DOME TYPE (Camera model No.)
- VENDOR (Manufacturer name)
- VERSION (Factory version N)

Dome OSD

Press the “DOME OSD” button on remote controller to display and make changes to the camera’s Pan and Tilt functions and its operation. When changes are made to these settings, their values are stored in the camera’s nonvolatile memory.

These setting include:

- PAN SPEED Default value: 30
 - Adjustable pan movement speed scope 1~63
- TILT SPEED Default value: 30
 - Adjustable tile movement speed scope 1~63
- SCAN SPEED Default value: 6
 - Adjustable pan movement speed scope 1~63
- TOUR PATH Default value: 1
 - Optional tour path at 1~4
- TOUR DWELL(Tour duration time) Default value: 5
 - Tour duration is 1~60 seconds
- PROPORTION (Speed matching) Default value: ON
 - ON enable speed match function
- AUTO REV Default value: P
 - (P) Image auto flip (positive) / (N) upside down/OFF
- FRAME FORMAT Default value: 1080i/60
 - Other Settings - 1080p/30, 1080p/25, 1080p/24, 1080i/60, 1080i/50, 720p/60, 720p/50
- OUTPUT TYPE Default value: DVI
 - Other settings - HDMI / DVI
- ASPECT RATIO (display mode) Default value: 16:9
 - Other settings - 16:9/4:3



LENS OSD

Press “LENS OSD” button on remote controller to display and make changes to the camera’s Lens and its image quality. When changes are made to these settings, their values are stored in the camera’s nonvolatile memory.

- ISS (Image Stable Mode) Default value: NO
 - SUPPORT/NO Support option
- ISE (Image Stable Mode) Default value: OFF
 - ISE: ON/OFF
- BLC (Back light comp) Default value: OFF
 - BLC: ON/OFF
- SELECT SCENE Default value: INACTIVE
 - Select scene: ACTIVE/INACTIVE
- SELECT SCENE Default value: NIGHT
 - Under Active situation: AUTO/WDR/HIGH/NIGHT option
- METERING LIGHT MODE Default value: WDR
 - Optional Mode: CENTER/SPOT/WDR
- EXPOSE MODE Default value: PAE
 - Mode option: MANUAL/PAE/AAE/SAE
- APERTURE MODE Default value:F1.8
 - Aperture range: F1.8—F11
- SHUTTER SPEED Default value:1/5
 - Shutter speed range: 1/5—1/4000
- EV CORRECTION Default value:+0
 - Option value: -2/-1.66/-1.33/-1/-0.66/-0.33/0/ +0.33/+0.66/+1/ +1.33/+1.66/+2
- ISO SENSITIVITY Default value: AUTO
 - Option value: AUTO / MANUAL
- MANUAL SETUP Default value:ISO80
 - Under manual ISO sensitivity, the parameter could be set to:
ISO80/ISO100/ISO200/ISO400/ISO800 /ISO1000
- FLICKER REDUCTION Default value: ON
 - Option: ON / OFF
- WHITE BALANCE Default value: AUTO
 - Option value: AUTO/CUSTOM/MANUAL/DAYLIGHT
/CLOUDY/SHADE/FLW/FLN/FLD/TUNGSTEN
- DIGITAL EFFECT Default value: NORMAL
 - Value option: NORMAL/SEPIA/MONOCHROM/ POSTERIZE/SOLARIZE/NEGA
- SHARPNESS REDUCTION Default value: MIDDLE
 - Setting option: HIGH/MIDDLE/LOW
- NOISE REDUCTION Default value: MIDDLE
 - Setting option: HIGH/MIDDLE/LOW/OFF
- CHROMA KEY CR Default value: LOW
 - Setting option: HIGH/MIDDLE/LOW
- CHROMA KEY CB Default value: LOW
 - Setting option: HIGH/MIDDLE/LOW
- AUTO SLOW SHUTRER Default value: OFF
 - In the situation of the light is dark to increase lighting volume.

IR Remote Controller

1. Reset: Restart Camera and restore to factory default settings
2. Camera Selection Select Camera of IR 1,2,3
3. Preset positions 1-9: positions
 - a. Set: Setting preset position
 - b. Clear: Clear preset position
 - c. Call: Call preset position Note: if you need set number 1 preset position, you should press Number key “1”, then press “Set” to setting this position;
4. Zoom in/out Controls
 - a. + Zoom in
 - b. - Zoom out
5. Pan/tilt Controls
 - a. Move up
 - b. Move down
 - c. Move left
 - d. Move right
 - e. Auto Pan moving
6. Additional Functions (**Note:** These settings are not stored in the camera’s nonvolatile memory. To store select the Dome OSD and make a slight change and then exit.)
 - a. Freeze: image freeze
 - b. BL: Backlight compensation
 - c. WB: White Balance
 - d. AE: Auto Exposure
 - e. D zoom: Digital Zoom
 - f. HDMI: Change to HDMI Video output
 - g. DVI: Change to DVI video output
7. Camera Power Control - Switch from stand by and operational
8. OSD Menu Zone
 - a. Dome OSD – Enter Dome OSD menu
 - b. Lens OSD – Enter Lens OSD menu
9. Slow Zoom in/out Zone
 - a. + Zoom in slowly
 - b. - Zoom out slowly
10. Focus Control Zone
 - a. Auto: auto focus of lens
 - b. Manual: manual focus of lens
 - c. Far: focus at far distance objects
 - d. Near: focus at near distance objects
11. Pan/Tilt Function Zone
 - a. L-Limit: Set Left limit Scanning position
 - b. Scan: Enable Boundary scanning
 - c. R-Limit: Set Right limit scanning position
 - d. Home: Camera Home position
 - e. Tour: Enable Patrolling
12. Rev: Image auto-flip

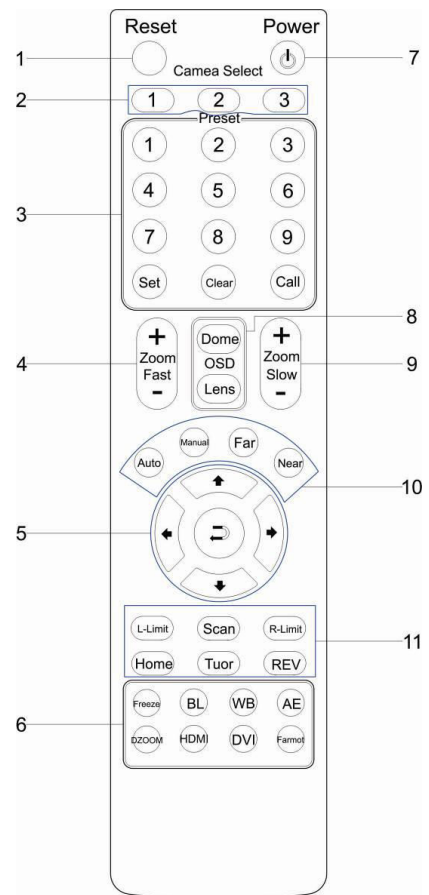

Camera Switch Settings

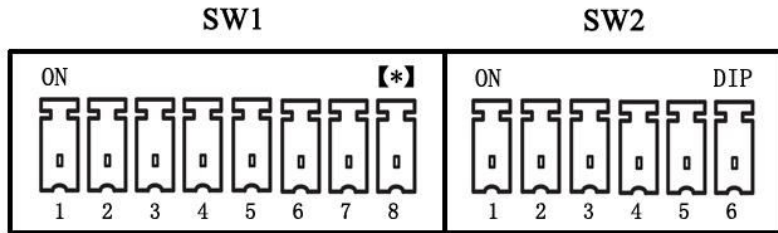

SW1 Address Setting Table

SW1 Switch code state(1-7 Bit)								
	DIP-1	DIP-2	DIP-3	DIP-4	DIP-5	DIP-6	DIP-7	
1	ON	OFF	OFF	OFF	OFF	OFF	OFF	Default
2	OFF	ON	OFF	OFF	OFF	OFF	OFF	
3	OFF	OFF	ON	OFF	OFF	OFF	OFF	
4	OFF	OFF	OFF	ON	OFF	OFF	OFF	
5	OFF	OFF	OFF	OFF	ON	OFF	OFF	
6	OFF	OFF	OFF	OFF	OFF	ON	OFF	
7	OFF	OFF	OFF	OFF	OFF	OFF	ON	

Notes: PELCO protocol

Broadcast address: If the sent address is 255, any camera can be controlled.

Test Address: If the camera address is set to 0, any address code can control the camera.

SW2 Communication Protocol Settings

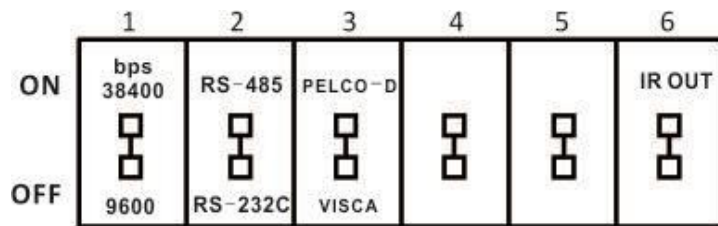

Default – All Off

Switch 1 – Baud Rate: On 38400 / Off 9600

Switch 2 – Transmission Type: On RS-485 / Off RS-232

Switch 3 – Protocol Type: On PELCO / Off VISCA

Switch 4 – IR Address Select (See Below)

Switch 5 – IR Address Select (See Below)

Switch 6 – IR: On Address Enabled / Off IR Address Disabled

IR Address Select

IR Select	SW2(4-5 Bit) Switch State	
	DIP-4	DIP-5
1	OFF	ON
2	ON	OFF
3	ON	ON

Notes: When the IR select value is zero, any address of the remoter controller can control the camera.

Installation

The Camera can be mounted on the wall or ceiling using the bracket or tripod mount. When mounted to a wall, you must use a shelf type mount and not mount the camera directly to the wall. Do not use a heavy HDMI cable directly connected to the camera. Instead, use a smaller size adapter cable to reduce strain on the HDMI connector.

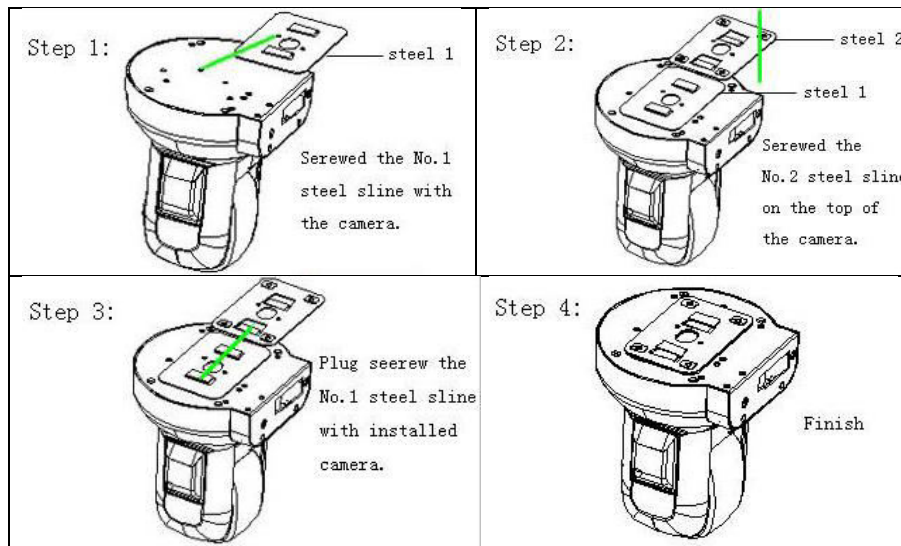

Size

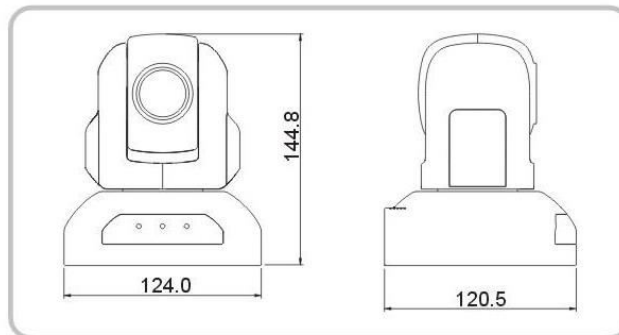

Specifications

Model		HD-380
Image Sensor	CCD	1/2.5 model, primary color CMOS, 2.1 M compatible
	Minimum Scene Illumination	6Lux(F1.8/50IRE/TV=1/30sec, 1920×1080movie) 1Lux (F1.8/50IRE/TV=1/8sec, 1920x1080 movie night mode)
	White Balance	auto/daylight/cloudy/shade/fluorescent lamp W (white)/fluorescent lamp N (Natural)/fluorescent lamp D (daylight) / tungsten /custom/manual
	Gain Control	Auto
	Back-light compensation	On/Off
	Electronic shutter	1/50-1/4,000S
	S/N Ratio	>50dB
Lens	Focus	Auto/Manual
	Iris	Auto/Manual
	Zoom	10 Optical Zoom f = 4.5 – 45.0 mm F1.8 – 2.2
Video Output		HD-SDI, HDMI
Video Format		1080P@30, 1080P@25, 1080P@24, 1080I@60, 1080I@50, 720P@60, 720P@50
Communication		RS-485 EIA/RS-232C (Bidirectional)
Protocol		PELCO_P, PELCO_D, VISCA
Baud Rate		38400/9600 bps (9600 Default)
Presets		64 presets (PELCO) 63 (VISCA)
OSD Menu		Supported
Auto Rev		P/N/OFF (Support auto reverse)
Pan Speed		0-280 degree per second
Tilt Speed		0-100 degree per second
Pan Rotation Angle		(59 degrees continuously)
Tilt Rotation Angle		240 degrees

TEK 380-HD Conference Camera

Auto Pan Scan	Supported
Boundary Scan	0-359 degree
Remoter Control	IR wireless control P/T/Z
Power Supply	DC 12V+-10%; 1.2A
Temperature and humidity	0-60 °C(Temperature), 0-95% RH
Size	W: 4.9-4.7-5.7 in / H: 6.6-5.7-6.3 in
Weight	1.76 lbs / 2.86 lbs (Package)

Specifications are subject to change without notice.



VISCA PROTOCOL

Protocol for the TEK 380-HD Camera is similar, but not identical to the Sony® VISCA™ command set. There are extra commands that are supported by this camera that are not in the VISCA commands.

Command Set

Command Type	Command	Packet	Comments
Address Set	Broadcast	88 30 01 FF	Address Set (Daisy chain)
IF Clear	Broadcast	88 01 00 01 FF	IF Clear
Command Cancel		8x 2p FF	p:socket number(1,2)
Camera Power	On Off (Standby)	8x 01 04 00 02 FF 8x 01 04 00 03 FF	Power On/Off
Camera Zoom	Stop Tele(Standard) Wide(Standard) Tele(Variable) Wide(Variable) Direct Direct(Variable)	8x 01 04 07 00 FF 8x 01 04 07 02 FF 8x 01 04 07 03 FF 8x 01 04 07 2p FF 8x 01 04 07 3p FF 8x 01 04 47 0p 0q 0r 0s FF 8x 01 7E 01 4A 0v 0p 0q 0r 0s FF	pqrs: Zoom Position* v:(Speed) 0-7
Camera Focus	Stop Far(Standard) Near(Standard) Far(Variable) Near(Variable) Auto Focus Manual Focus Auto/Manual Direct	8x 01 04 08 00 FF 8x 01 04 08 02 FF 8x 01 04 08 03 FF 8x 01 04 08 2p FF 8x 01 04 08 3p FF 8x 01 04 38 02 FF 8x 01 04 38 03 FF 8x 01 04 38 10 FF 8x 01 04 48 0p 0q 0r 0s FF	pqrs: Focus position
Camera WB	Auto Manual One Push WB	8x 01 04 35 00 FF 8x 01 04 35 05 FF 8x 01 04 35 03 FF	pqrs: Focus position
Camera AE	Auto Manual Shutter Priority Iris Priority	8x 01 04 39 00 FF 8x 01 04 39 03 FF 8x 01 04 39 0A FF 8x 01 04 39 0B FF	
Camera Shutter	Direct	8x 01 04 4A 00 00 0p 0q FF	pq: Shutter Position
Camera Iris	Direct	8x 01 04 4B 00 00 0p 0q FF	pq: Iris Position
Camera Back Light	On Off	8x 01 04 33 02 FF 8x 01 04 33 03 FF	Back Light Compensation ON/OFF
Camera Memory	Reset Set Recall	8x 01 04 3F 00 0p FF 8x 01 04 3F 01 0p FF 8x 01 04 3F 02 0p FF	p: Memory Number (=1 to 3F) Corresponds to 1 to 9 on the Remote
Video Format		8x 01 06 35 00 0p FF	p: Video format 1 1920×1080p/30 2 1920×1080i/ 60 3 1280×720p/60 9 1920×1080p/25 A 1920×1080i/50 B 1280×720p/50 D 1920×1080p/24

Command Type	Command	Packet	Comments
IR Receive	On Off	8x 01 06 08 02 FF 8x 01 06 08 03 FF	IR Receiver On/Off
Color system	RGB YPbPr	8x 01 7E 01 03 00 00 FF 8x 01 7E 01 03 00 01 FF	Color-reproduction format setting
Pan-tilt Drive	Up Down Left Right Up Left Up Right Down Left Down Right Stop Absolute Position Relative Position Home Reset	8x 01 06 01 VV WW 03 01 FF 8x 01 06 01 VV WW 03 02 FF 8x 01 06 01 VV WW 01 03 FF 8x 01 06 01 VV WW 02 03 FF 8x 01 06 01 VV WW 01 01 FF 8x 01 06 01 VV WW 02 01 FF 8x 01 06 01 VV WW 01 02 FF 8x 01 06 01 VV WW 02 02 FF 8x 01 06 01 VV WW 03 03 FF 8x 01 06 02 VV WW 0Y 0Y 0Y 0Y 0Z 0Z 0Z 0Z FF 8x 01 06 03 VV WW 0Y 0Y 0Y 0Y 0Z 0Z 0Z 0Z FF 8x 01 06 04 FF 8x 01 06 05 FF	VV: Pan speed 0 x01 (low speed) to 0 x18 (high speed) WW: Tilt Speed 0 x 01 (low speed) to 0 x14 (high speed) YYYY: Pan Position 0000 to 07E0 (left 0000) ZZZZ: Tilt Position 0000 to 01C8 (down 0000)
Pan-tilt Limit Set	Limit Set Limit Clear	8x 01 06 07 00 0W 0Y 0Y 0Y 0Y 0Z 0Z 0Z 0Z FF 8x 01 06 07 01 0W 07 0F 0F 0F 07 0F 0F 0F FF	W: 1 Up Right 0: Down Left YYYY: Pan Position 0000 to 07E0 (left 0000) ZZZZ: Tilt Position 0000 to 01C8 (down 0000)



Inquiry Command List

Command Type	Command Packet	Receive Packet	Comments
Camera Power Inquiry	8x 09 04 00 FF	y0 50 02 FF y0 50 03 FF y0 50 04 FF	On Off (Standby) Internal power circuit error
Camera Zoom Pos, Inquiry	8x 09 04 47 FF	y0 50 0p 0q 0r 0s FF	pqrs: Zoom Position
Camera Focus Mode Inquiry	8x 09 04 38 FF	y0 50 02 FF y0 50 03 FF	Auto Focus Manual Focus
Camera WB Mode Inquiry	8x 09 04 35 FF	y0 50 00 FF y0 50 01 FF y0 50 02 FF y0 50 03 FF y0 50 05 FF	Auto In Doors Out Doors One Push WB Manual
Camera AE Mode Inquiry	8x 09 04 39 FF	y0 50 00 FF y0 50 03 FF y0 50 0A FF y0 50 0B FF	Full Auto Manual Shutter Priority Iris Priority
Camera Shutter Pos, Inquiry	8x 09 04 4A FF	y0 50 00 00 0p 0q FF	pq: Shutter Position
Camera Iris Pos, Inquiry	8x 09 04 4B FF	y0 50 00 00 0p 0q FF	pq: Iris Position
Camera Back Light Mode Inquiry	8x 09 04 33 FF	y0 50 02 FF y0 50 03 FF	On OFF
Video Format Inquiry	8x 09 06 23 FF	y0 50 01 FF y0 50 02 FF y0 50 03 FF y0 50 09 FF y0 50 0A FF y0 50 0B FF y0 50 0D FF	1920×1080p/30 1920×1080i/60 1280×720p/60 1920×1080p/25 1920×1080i/50 1280×720p/50 1920×1080p/24
Camera Pan Tilt Pos, Inquiry	8x 09 06 12 FF	y5 50 0w 0w 0w 0w 0z 0z 0z 0z FF	www = Pan Position zzzz = Tilt Position Speed
Color System Inquiry	8x 09 7E 01 03 FF	y0 50 00 FF y0 50 01 FF	RGB YPbPr