

Room combining can become very expensive, especially when video matrix and DSP audio systems are required. These also require a lot of expensive software in order to work correctly. With the TEKVOX 71036 2 Room Combining Drop-In, you'll receive everything needed to combine and separate four rooms, including control software. This is achieved using TEK 51T presentation switchers for individual rooms and one TEK-MHD44TP HDBaseT 4x4 matrix switcher to connect them.

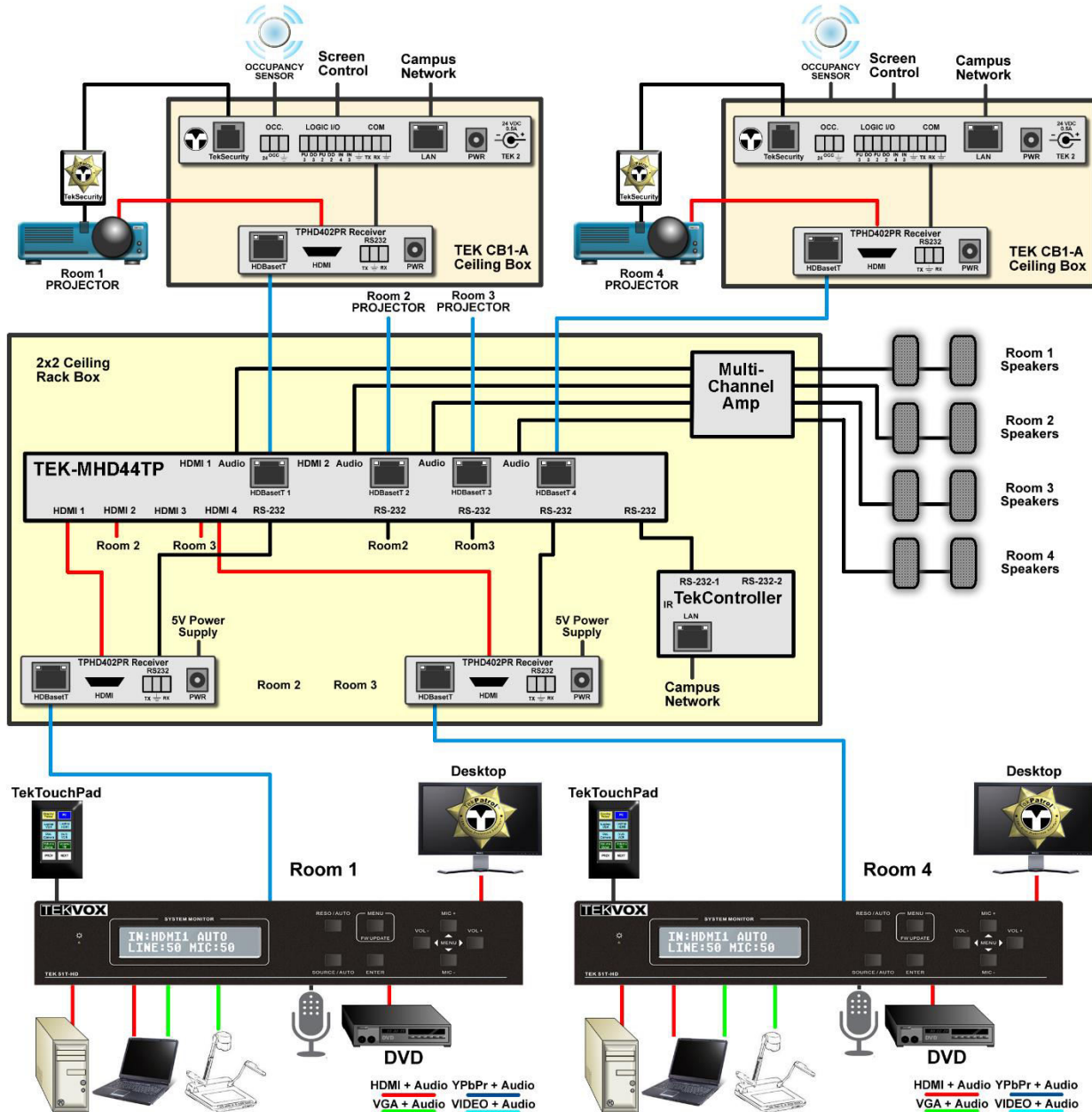

The following is included in a TEKVOX 2 Room Combining Drop-In 71036:

Part #	Description	Qty.
70001	TEK 2 - TekMonitor	2
10030	TekMonitor Power Supply	2
78001	TekSecurity With 4' RJ12 Cable	2
*78006	TekSecurity Cable for projector	2
78002	SR Occupancy Sensor	2
78038	TEK CB1-A Ceiling Box	2
78036	TEK TSC7 Table Top Cubby	2
79063	TEK 51T-HD Presentation Switcher	2
79040	TEK TPHD402PR HDBaseT receiver	2
78034	TekTouchPad	2
78035	TekTouchPad Wedge	2
79055	MHD44TP Switcher	2
Custom	Room Controlling Software	1

*TekSecurity cables are ordered for the different types of displays.